

MODEL B701

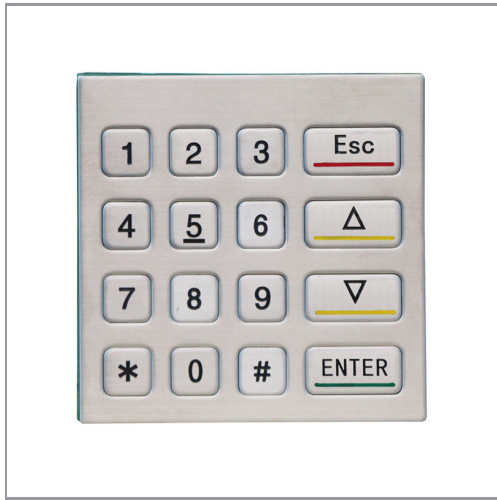

DESCRIPTION

The 12 or 16 key S-series keypads are specially designed for public environment applications, such as vending machines, ticket machines, payment terminals, telephones, access control systems and industrial machinery.

Keys and front panel are built from SUS304# stainless steel with high resistance to impact and vandalism and is also sealed to IP67.

1 MAIN COMPONENTS

- Frame and keys are made of SUS304# stainless steel material
- Conductive metal domes
 - Working life: 1 million cycles of operation per key
 - Elastic force: 250g
- 1.5mm thickness UL approved printed circuit board with golden fingers

2 STRUCTURE DRAWING

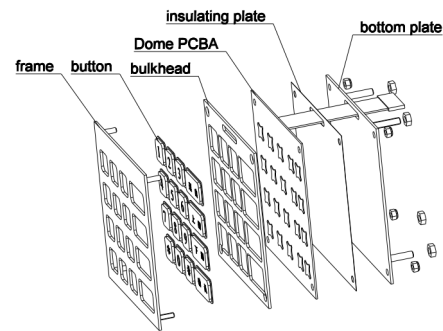

3 DIMENSION DRAWING

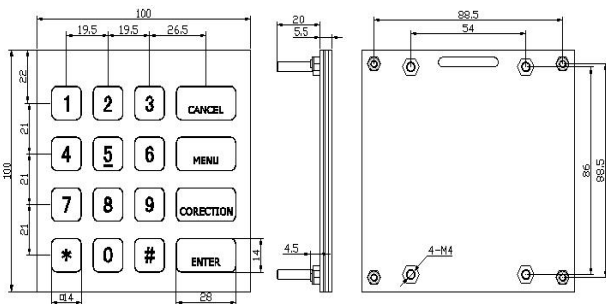

4 COMMON CIRCUIT

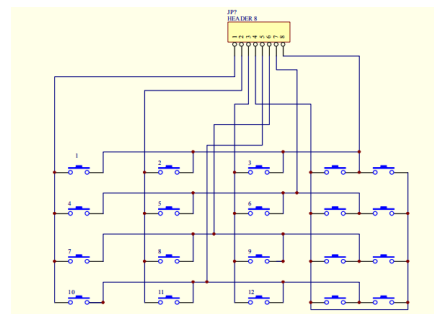

5 SPECIFICATION

Electrical Specification	Power Supply	Nominal 3 VDC	
		Max. voltage 12VDC	
		Min. voltage 3VDC	
Mechanical Characteristics	Storage Temperature	-40℃ ... +85℃	
	Operation Temperature	-25℃ ... +65℃	
	Protection Grade	IP67	
	Shock Resistance	IK09	
	Electrical Life	1 million cycles of operation per key	
	Key Travel	0.45mm	
	Environmental Resistance	Actuation Force	250g/2.45N
			Damp heat 21 days +40℃
Saline mist 96 Hours			
		Dry heat 10 days +85℃	

6 CONNECTOR

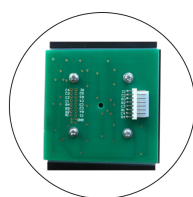

Plug Connector

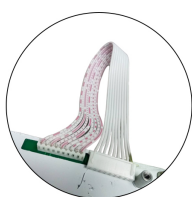

SCN plug+cable



XH plug+cable

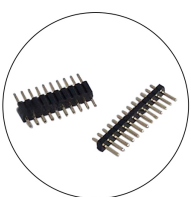

Pins header



DB9 Connector



USB

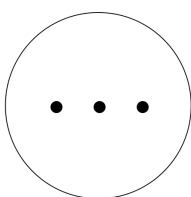

More

7 APPLICATION

